

适用测头

测头的规格

测头	VAST XXT		XDT
	TL3	TL4	
最大轴向测针长度 (mm)	30 - 150	125 - 250	30 - 150
最大横向测针长度 (mm)	65	40	65
最大测针重量 (g)	15	10	15
最小测针针尖半径 (mm)	Φ 0.3		
最大ThermoFit测头延长杆长度 (mm)	100		



测针/加长杆

M3	概略形状	型号	各部尺寸 (mm)							B	重量 (g)
			DK	L	DG	ML	MLE	DS	DSE		
球测针 (超硬合金测杆, 红宝石球)		602030-8119-000	1.5	22	4	9		1			1
		602030-8023-000	2	21	4	15		1			1
		602030-8021-000	3	21.5	4	15.5		1.5			1
		602030-8113-000	3	40	4	24		2			4
		626113-0080-014	0.8	14	5	5		0.6			0.62
		626113-0100-014	1	14	5	5		0.8			0.63
		626113-0150-014	1.5	14	5	5		1			0.65
		626113-0150-020	1.5	20	5	11		1			0.72
		626113-0151-030	1.5	30	5	21		1			0.84
		626113-0150-030	1.5	30	5	22.5		1			0.9
		626113-0151-040	1.5	40	5	31		1			1.6
		626113-0200-014	2	14	5	5		1			0.66
		626113-0200-020	2	20	5	11		1			0.72
		626113-0200-030	2	30	5	21		1			0.83
		626113-0201-040	2	40	5	31		1.5			1.7
626113-0250-020	2.5	20	5	11		1.5			1		
626113-0250-030	2.5	30	5	21		1.5			1.5		
626113-0250-040	2.5	40	5	31		1.5			2		
球测针 (陶瓷测杆, 红宝石球)		602030-8102-000	4	32	4	24		2			1
		602030-8101-000	5	32.5	4	24.5		2			1
		602030-8020-000	6	13	4	8.9		2			1
球测针 (ThermoFit测杆, 红宝石球)		626103-0300-025	3	25	5	16		2			0.65
		626103-0300-033	3	33	5	24		2			0.7
		626103-0300-042	3	42	5	33		2			0.8
		626103-0300-050	3	50	5	41		2			0.8
		626103-0300-059	3	59	5	50		2			1
		626103-0300-075	3	75	5	66		2			1
		626103-0401-050	4	50	5	41		2			1
		626103-0500-030	5	30	5	21		3.5			1.1
		626103-0500-040	5	40	5	31		3.5			1.2
		626103-0500-050	5	50	5	41		3.5			1.4
		626103-0500-060	5	60	5	51		3.5			1.5
		626103-0501-075	5	75	5	66		3.5			1.8
		626103-0600-050	6	50	5	40		3.5			1.5
		626103-0610-070	6	70	5	61		3.5			1.8
		626103-0600-100	6	100	5	91		3.5			2.4
		626103-0800-030	8	30	5	30		5			1.86
		626103-0830-050	8	50	5	50		5			2.1
		626103-0830-070	8	70	5	70		5			2.6
		626103-0830-100	8	100	5	100		5			2.7
		626103-0800-125	8	125	5	125		5			2.9

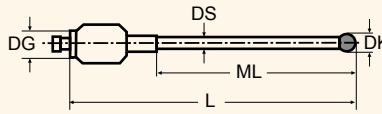
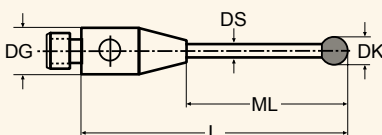
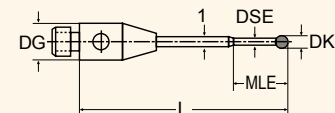
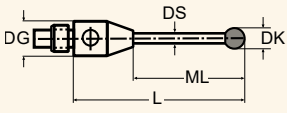
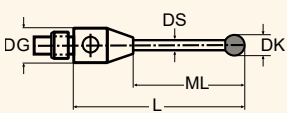
M3	概略形状	型号	各部尺寸 (mm)							重量 (g)
			DK	L	DG	ML	MLE	DS	DSE	
球测针 (塑料/ ThermoFit测杆, 红宝石球) 		626103-0207-020	2	20	5	8		1		0.96
		626103-0207-025	2	25	5	13		1		0.98
		626103-0207-030	2	30	5	18		1		0.98
		626103-0307-030	3	30	5	18		2		1.08
		626103-0307-040	3	40	5	28		2		1.15
		626103-0307-050	3	50	5	38		2		1.21
		626103-0507-040	5	40	5	30		3		1.49
		626103-0507-050	5	50	5	40		3		1.62
		626103-0507-075	5	75	5	65		3		1.92
		626103-0807-040	8	40	5	30		3		2.24
球测针 (ThermoFit测杆, 氮化硅球) 		626103-0301-033	3	33	5	24		2		0.7
		626103-0301-050	3	50	5	41		2		0.8
		626103-0502-050	5	50	5	41		3.5		1.4
		626103-0500-075	5	75	5	66		3.5		1.8
		626103-0801-070	8	70	5	70		5		2.6
		626103-0801-125	8	125	5	125		5		2.9
球测针 (超硬合金测杆, 红宝石球) 		602030-8121-000	0.3	22	4		2.3		0.2	1
		602030-8115-000	0.5	22	4		2.5		0.3	1
		602030-8116-000	0.6	22	4		4.6		0.4	1
		602030-8117-000	0.8	22	4		4.8		0.6	1
		602030-8118-000	1	22	4		5		0.8	1
		626113-0030-013	0.3	13	5		2.3		0.2	0.62
		626113-0030-020	0.3	20	5		2.3		0.2	0.69
		626113-0050-013	0.5	13	5		2.3		0.3	0.61
		626113-0050-020	0.5	20	5		2.3		0.3	0.69
		626113-0060-014	0.6	14	5		4.6		0.4	0.61
		626113-0060-020	0.6	20	5		4.6		0.4	0.68
		626113-0080-014	0.8	14	5		4.8		0.6	0.62
		626113-0080-020	0.8	20	5		4.8		0.6	0.69
		626113-0080-034	0.8	34	5		4.1		0.6	0.8
		626113-0101-020	1	20	5		5.1		0.6	0.7
		626113-0100-020	1	20	5		5		0.8	0.69
		626113-0100-030	1	30	5		5		0.8	0.8
		626113-0100-040	1	40	5		5		0.8	1.5
		626113-0103-020	1	20	5		11		0.8	0.7
		626113-0150-035	1.5	35	5		26		1	0.9
626113-0300-050	3	49.5	4		41.5		2	2.6		
星形测针用夹球测针 (ThermoFit测杆, 红宝石球) 		626103-0301-020	3	20	5	11		2		0.7
		626103-0301-030	3	30	5	21		2		0.75
		626103-0301-040	3	40	5	31		2		0.8
星形测针用夹球测针 (ThermoFit测杆, 氮化硅球) 		626103-0311-020	3	20	5	11		2		0.7
		626103-0311-030	3	30	5	21		2		0.75
		626103-0311-040	3	40	5	31		2		0.8

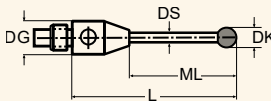
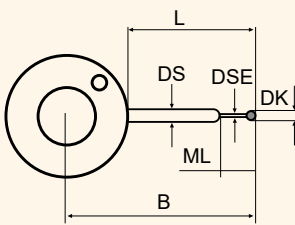
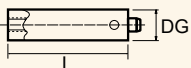
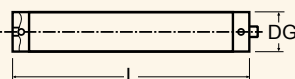
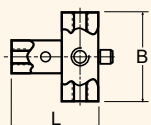
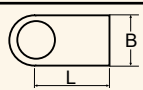
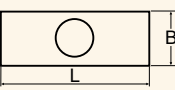
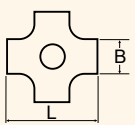
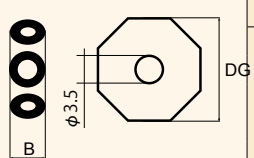
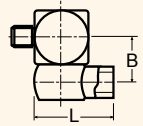
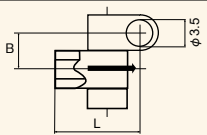

M3	概略形状	型号	各部尺寸 (mm)							重量 (g)	
			DK	L	DG	ML	MLE	DS	DSE		B
1/4 星形球测针 (ThermoFit测杆, 红宝石球)		626103-0302-020	3	20	5	11		2			0.8
		626103-0302-030	3	30	5	21		2			0.9
		626103-0302-040	3	40	5	31		2			1
1/4 星形球测针 (ThermoFit测杆, 氮化硅球)		626103-0312-020	3	20	5	11		2			0.8
		626103-0312-030	3	30	5	21		2			0.9
		626103-0312-040	3	40	5	31		2			1
1/2 90° 星形球测针 (ThermoFit测杆, 红宝石球)		626103-0303-020	3	20	5	11		2			1.4
		626103-0303-030	3	30	5	21		2			1.5
		626103-0303-040	3	40	5	31		2			1.6
1/2 90° 星形球测针 (ThermoFit测杆, 氮化硅球)		626103-0313-020	3	20	5	11		2			1.4
		626103-0313-030	3	30	5	21		2			1.5
		626103-0313-040	3	40	5	31		2			1.6
1/2 180° 星形球测针 (ThermoFit测杆, 红宝石球)		626103-0304-020	3	20	5	11		2			1.4
		626103-0304-030	3	30	5	21		2			1.5
		626103-0304-040	3	40	5	31		2			1.6
1/2 180° 星形球测针 (ThermoFit测杆, 氮化硅球)		626103-0314-020	3	20	5	11		2			1.4
		626103-0314-030	3	30	5	21		2			1.5
		626103-0314-040	3	40	5	31		2			1.6
星形测针 (超硬合金测杆, 红宝石球)		626103-0030-016	0.3	4	5	2.3		1	0.2	16	0.91
		626103-0030-025	0.3	8.5	5	2.3		1	0.2	25	1.13
		626103-0050-016	0.5	4	5	2.3		1	0.3	16	0.92
		626103-0050-025	0.5	8.5	5	2.3		1	0.3	25	1.15
		626103-0060-018	0.6	5	5	4.6		1	0.4	18	0.92
		626103-0060-025	0.6	8.5	5	4.6		1	0.4	25	1.1
		626103-0080-018	0.8	5	5	4.8		1	0.6	18	0.82
		626103-0080-025	0.8	8.5	5	4.8		1	0.6	25	1
		626103-0100-018	1	5	5	5		0.8		18	0.87
		626103-0100-025	1	8.5	5	5		1	0.8	25	1.05
		626103-0150-018	1.5	5	5	5		1		18	0.95
		626103-0150-025	1.5	8.5	5	8.5		1		25	1.12
626103-0200-018	2	5	5	5		1		18	0.92		
626103-0200-025	2	8.5	5	8.5		1		25	1.1		
半球测针 (陶瓷)		626103-1200-012	12	12	5					8	2.32
		626103-1500-012	15	12	5					9	3.29

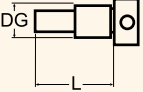
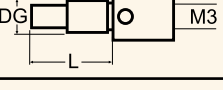
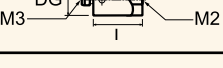
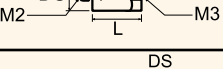
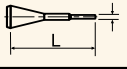
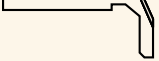
M3	概略形状	型号	各部尺寸 (mm)								重量 (g)	
			DK	L	DG	ML	MLE	DS	DSE	B		
球测针 (ThermoFit测杆, 红宝石球)		626103-0501-030	5	30	5	21		3.5			1.1	
		626103-0501-050	5	50	5	41		3.5			1.4	
L型测针 (超硬合金测杆, 红宝石球)		626103-0030-416	0.3	4		2.3		1	0.2	8	0.9	
		626103-0030-425	0.3	8.5		2.3		5	0.2	12.5	1	
		626103-0050-416	0.5	4		2.3		1	0.3	8	0.9	
		626103-0050-425	0.5	8.5		2.3		1	0.3	12.5	1	
		626103-0060-418	0.6	5		4.6		1	0.4	9	0.9	
		626103-0060-425	0.6	8.5		4.6		1	0.4	12.5	0.9	
		626103-0080-418	0.8	5		4.8		1	0.6	9	0.9	
		626103-0080-425	0.8	8.5		4.8		1	0.6	12.5	0.9	
		626103-0100-418	1	5		5			0.8	9	0.9	
		626103-0100-425	1	8.5		5			1	0.8	12.5	1
		626103-0150-418	1.5	5		5			1	9	0.9	
		626103-0150-425	1.5	8.5		8.5			1	12.5	1	
		626103-0200-418	2	5		5			1	9	0.9	
		626103-0200-425	2	8.5		8.5			1	12.5	1	
		测针加长杆 (不锈钢)		602030-8301-000		10	4					
602030-8302-000				20	4						1	
602030-8303-000				30	4						2	
602030-8304-000				40	4						3	
602030-8305-000				50	4						4	
测针加长杆(ThermoFit)		626103-5030-000		30	5						1.3	
		626103-5040-000		40	5						1.4	
		626103-5050-000		50	5						1.5	
		626103-5060-000		60	5						1.7	
		626103-5080-000		80	5						1.8	
		626103-5100-000		100	5						2.04	
		626103-5130-000		130	5						2.5	
		626103-5150-000		150	5						2.7	
		626103-5045-010		45	5						1.5	
5方向连接件		602030-8382-000		11.5						12	4.0	
90° 转角测针接头		626103-6110-001		6.5						5	0.64	
180° 转角测针接头		626103-6110-002		13						5	1.05	
4边形测针立方块		626103-6110-003		13						5	1.8	
8边形测针立方块		626103-6110-007	M3		14					5	2.31	
可变关节接头		602030-9102-000		12						6	3	
可变关节接头		626103-6180-001		10						5	1.65	

M3	概略形状	型号	各部尺寸 (mm)						重量 (g)
			DK	L	DG	ML	DS	B	
夹紧螺钉		626103-6110-004		8	5				0.5
夹紧螺钉 (可装配M3测针)		626103-6110-005		8	5				0.7
M3转M2接头		602030-8341-000		5	4				0.5
M2转M3接头		602030-8345-000		5	4				1
针形扳手		602030-0001-000		12			1.2		
M3测针工具扳手		000000-1018-201							

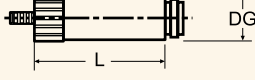
M3	概略形状	型号	摘要						
XXT用测针安装辅助工具		626109-0026-000							
钩形扳手 (Φ5mm)		626109-0018-000							
针形扳手(Φ 1.1 mm)		000000-0015-323							
清洗剂		000000-0084-895	清洗剂 (IFA-CLEAN) : 1 t						

XXT	概略形状	型号	各部尺寸 (mm)						重量 (g)
			DK	L	DG	ML	DS	B	
适用于XXT的ThermoFit测头延长杆		620161-8701-000		60	24				58
		620161-8703-000		100	24				75

XXT	概略形状	型号	备注						重量 (g)
测针吸盘		620161-8075-000	TL3						4.6
		620161-8078-000	TL3 基准针用						4.6
一体式测针吸盘		620161-8065-000	TL4 (A型)						5.4
		620161-8068-000	TL4 基准针用 (A型)						5.4
		626103-8033-055	TL3 (B型)						6.3

转接板 RDS 测座和VAST XXT/XDT测头的接头)

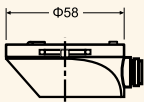
	概略形状	型号	备注						重量 (g)
RDS的转接板		620670-9550-000	配 VAST XXT 使用						160



适用测头

测头规格

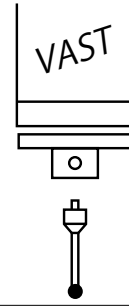
Probe Heads	VAST XT VAST XT gold
测针+ 测针加长杆的最大长度 (L)	500 mm
最小测针针尖直径(DK)	Φ 0.5 mm
测针+ 测针加长杆的最大重量	500 g

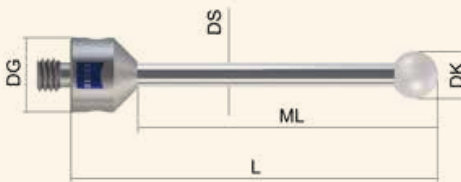
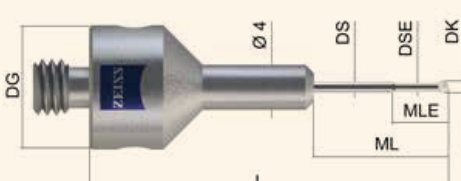
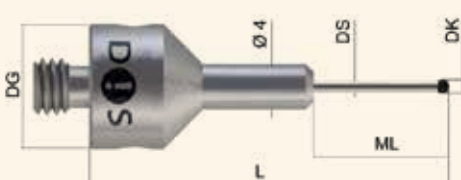

测针/测针加长杆

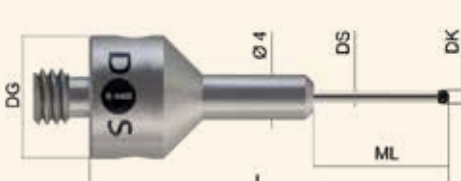
M5	概略形状	型号	各部尺寸 (mm)								重量 (g)
			DK	L	DG	ML	MLE	DS	DSE	B	
金刚石测针, M5 (超硬合金测杆, 金刚石球) 	626115-0209-020	2	20	11	9		1.5			5.6	
	626115-0309-025	3	25	11	15		2			6.7	
	626115-0309-033	3	33	11	23		2			7.1	
	626115-0309-050	3	50	11	40		2			7.8	
	626115-0309-058	3	58	11	48		2			8.2	
	626115-0309-064	3	64	11	54		2			8.5	
	626115-0309-075	3	75	11	65		2			9	
	626115-0309-090	3	90	11	80		2.5			10	
金刚石测针, M5, 阶梯型 (超硬合金测杆, 金刚石球) 	626115-0109-022	1	22	11	12	5	1	0.8		5.7	
	626115-0109-032	1	32	11	12	5	1	0.8		7.2	
	626115-0209-058	2	58	11	48	33	4	1.5		5	
金刚石涂层测针, M5, 阶梯型 (超硬合金测杆, 金刚石涂层球) 	626115-0119-032	1.05	32	11	22	12	4	1		7.2	
	626115-0219-032	2.05	32	11	12		1.5			7.4	
	626115-0219-044	2.05	44	11	34	19	4	1.5		8.1	
	626115-0219-058	2.05	58	11	48	33	4	1.5		8.5	
金刚石涂层测针, M5, (超硬合金测杆, 金刚石涂层球) 	626115-0219-020	2.05	20	11	10		1.5			6.2	
	626115-0219-034	2.05	34	11	24		1.5			6.5	
	626115-0310-075	3.05	75	11	65		2			8.9	
	626115-0311-058	3.05	58	11	48		2			8.1	
	626115-0319-033	3.05	33	11	23		2			7	
	626115-0319-050	3.05	50	11	40		2			7.7	
	626115-0319-064	3.05	64	11	54		2			8.4	
	626115-0319-100	3.05	100	11	90		2			10	
金刚石涂层测针, M5, 阶梯型 (超硬合金测杆, 金刚石涂层球) 	626115-0519-050	5.05	50	11	40		3.5			9	
	626115-0519-075	5.05	75	11	65		3.5			13	
	626115-0519-100	5.05	100	11	90		3.5			20	
	626115-0819-064	8.05	63.5	11	50.5		6			29	
	626115-0819-115	8.05	114.5	11	101.5		6			49	

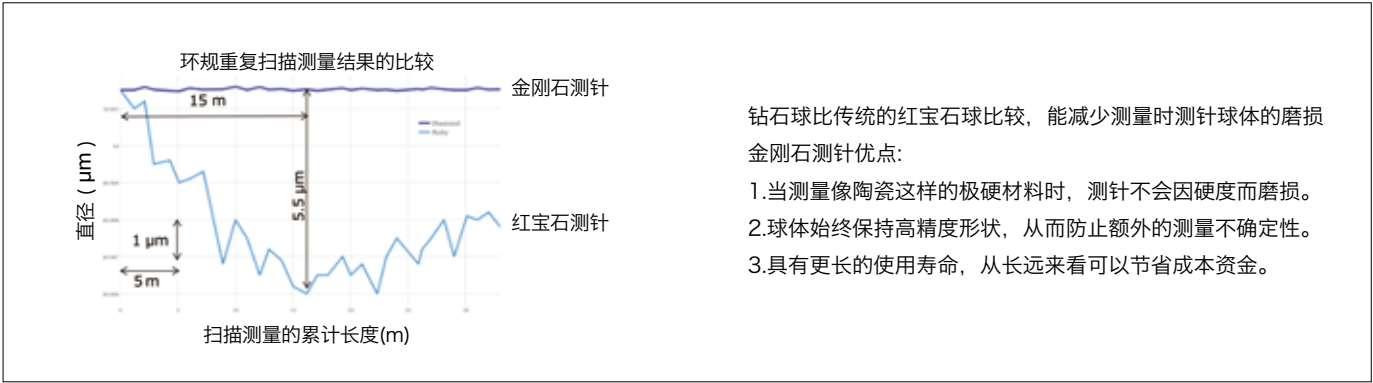

钻石球比传统的红宝石球比较，能减少测量时测针球体的磨损
 金刚石测针优点：

- 1.当测量像陶瓷这样的极硬材料时，测针不会因硬度而磨损。
- 2.球体始终保持高精度形状，从而防止额外的测量不确定性。
- 3.具有更长的使用寿命，从长远来看可以节省成本资金。

M5	概略形状	型号	各部尺寸 (mm)							重量 (g)	
			DK	L	DG	ML	MLE	DS	DSE		B
球测针 (超硬合金测杆, 红宝石球)		602030-9010-000	3	25	11	15		2			4
		600342-8020-000	3	33.5	11	23.5		2			4
		602030-9011-000	3	50	11	40		2			5
		600342-8021-000	3	58	11	48		2			6
		600342-8025-000	4	33.5	11	23.5		2			4
		602030-9012-000	4	64	11	54		2			6
		602030-9013-000	5	50	11	40		3.5			9
		602030-9015-000	5	75	11	65		3.5			13
		600342-8026-000	6	54	11	44		3.5			10
		600342-8027-000	7	55	11	45		3.5			10
		600342-8023-000	8	63.5	11	50.5		6			25
		602030-9016-000	8	75	11	62		6			30
		602030-9017-000	8	100	11	87		6			41
		600342-8024-000	8	114.5	11	101.5		6			48
		600342-8124-000	8	114.5	19	92.5		6			59
		600342-8128-000	9	64.5	19	42.5		6			38
600342-8029-000	10	65.5	11	52.5		6			27		
602030-9018-000	10	118	11	105		6			47		
球测针 (ThermoFit测杆, 红宝石球)		626105-0300-025	3	25	11	15		2			4
		626105-0300-033	3	33	11	23		2			4
		626105-0300-050	3	50	11	40		2			4
		626105-0300-058	3	58	11	48		2			4
		626105-0400-033	4	33	11	23		2			4
		626105-0400-064	4	64	11	54		2			4
		626105-0510-050	5	50	11	40		3.5			4
		626105-0510-075	5	75	11	65		3.5			5
		626105-0510-100	5	100	11	90		3.5			5
		626105-0610-054	6	54	11	44		3.5			5
		626105-0710-055	7	55	11	45		3.5			5
		626105-0820-063	8	63	11	50		6			7
		626105-0820-075	8	75	11	62		6			8
		626105-0820-100	8	100	11	87		6			9
		626105-0820-114	8	114	11	101		6			10
		626105-0820-150	8	150	11	137		6			12
626105-0820-200	8	200	11	187		6			14		
626105-1020-065	10	65	11	52		6			8		
626105-1020-118	10	118	11	105		6			11		
626105-1020-150	10	150	11	137		6			13		
626105-1020-200	10	200	11	187		6			15		
球测针 (ThermoFit测杆, 氮化硅球)		626105-0301-033	3	33	11	23		2			4
		626105-0301-058	3	58	11	48		2			4
		626105-0511-050	5	50	11	40		3.5			4
		626105-0511-075	5	75	11	65		3.5			5
		626105-0511-100	5	100	11	90		3.5			5
		626105-0821-063	8	63	11	50		6			7
		626105-0821-100	8	100	11	87		6			9
		626105-0821-114	8	114	11	101		6			10
		626105-0821-150	8	150	11	137		6			12
		626105-0821-200	8	200	11	187		6			14
		626105-1021-118	10	118	11	105		6			11
		626105-1021-150	10	150	11	137		6			12
626105-1021-200	10	200	11	187		6			15		

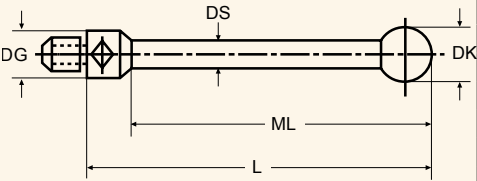
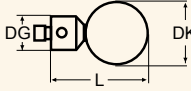
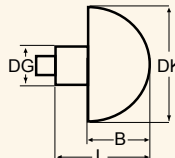
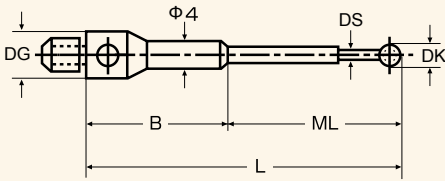
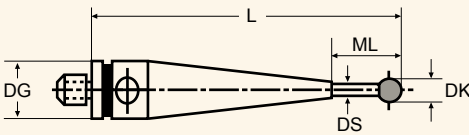
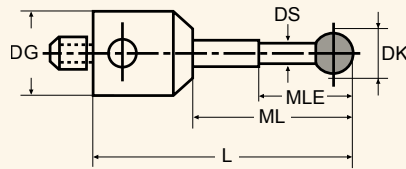
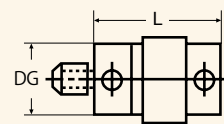
M5	概略形状	型号	各部尺寸 (mm)							重量 (g)
			DK	L	DG	ML	MLE	DS	DSE	
球测针 (陶瓷测杆, 红宝石球) 	600342-8013-000	5	53	11	43		3.5			5
	600342-8016-000	6	54	11	44		3.5			5
	600342-8014-000	8	63.5	11	50.5		6			8
	600342-8015-000	8	114.5	11	101.5		6			12
球测针 (陶瓷球) 	000000-1294-772	15	28	11						20
	626115-1600-028	16	28	11						20
	626115-1800-028	18	28	11						22
	626115-2000-033	20	33	11						29
	626115-3000-043	30	43	11						67
半球测针 (陶瓷) 	626105-1696-020	16	20	11					10	10.4
	626105-2296-025	22	23	11					14.5	13
	626105-3096-025	30	25	11					18	17
球测针 (超合金测杆, 红宝石球) 	602030-8060-000	0.8	32	11	12		1	0.6	20	4
	602030-8061-000	1	32	11	12		1	0.8	20	4
	602030-8062-000	1.35	32	11	12		1		20	4
	602030-8063-000	1.35	44	11	19		1		25	4
	602030-8064-000	1.5	32	11	12		1		20	4
	602030-8065-000	1.5	44	11	19		1		25	4
	602030-8066-000	2	32	11	12		1.5		20	7.2
	602030-8067-000	2	44	11	19		1.5		25	5
	602030-8068-000	2	58	11	33		1.5		25	5
	602030-8069-000	2.5	32	11	12		1.5		20	4
	602030-8070-000	2.5	44	11	19		1.5		25	5
	602030-8071-000	2.5	58	11	33		1.5		25	5
	球测针 (红宝石球) 	602030-9019-000	1	55	11	4		0.8		
602030-9020-000		1.5	55	11	5		1			11
602030-9021-000		2	55	11	5		1.5			11
602030-9023-000		3.5	55	11	10		2.5			11
小直径球测针 (超合金测杆, 红宝石球) 	626115-0030-022	0.3	21.8	11	12.8	2.3	1	0.2		6
	626115-0050-022	0.5	22	11	13	2.5	1	0.3		6
	626115-0060-022	0.6	22.1	11	13.1	4.6	1	0.4		5.4
	626115-0080-022	0.8	22.3	11	13.3	4.8	1	0.6		6
	626115-0100-022	1	22.5	11	13.5	5	1	0.8		6
360° 旋转接头 	626105-6280-090		30	20						40
	626105-6280-030		29	11						13

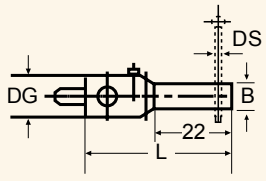
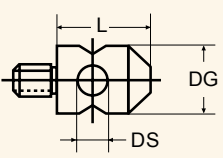
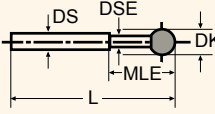
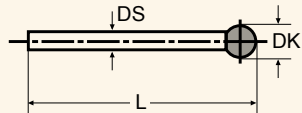
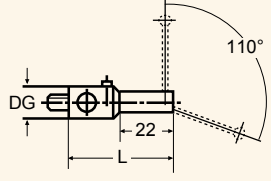
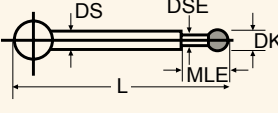
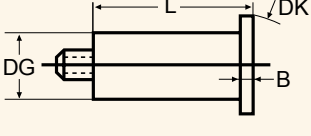
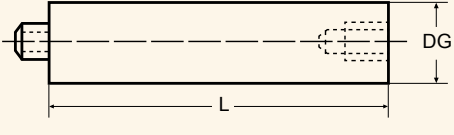
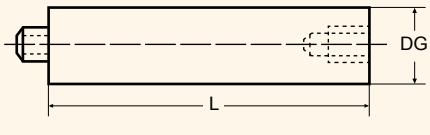
M5	概略形状	型号	各部尺寸 (mm)							重量 (g)	
			DK	L	DG	ML	MLE	DS	DSE		B
测针支座 (90°)		600341-8160-000		45	11			1.5		6	16
5方向测针支座		600341-8367-000		10	11			1			3
		600341-8368-000		10	11			1.5			3
极小径球测针 (HSS用)		600341-8454-000	1	16			5	1	0.8		1
		600341-8450-000	0.3	15.3			2.3	1	0.2		1
		600341-8451-000	0.5	15.5			2.5	1	0.3		1
		600341-8452-000	0.6	15.6			4.6	1	0.4		1
		600341-8453-000	0.8	15.8			4.8	1	0.6		1
小直径球测针		600341-8501-000	1.5	26.5	1						1
		600341-8502-000	2	27	1.5						1
		600341-8503-000	2.5	27.5	1.5						1
		600341-8500-000	1.35	26.35	1						1
可转测针支座		600341-8180-000		40	11						15
可转支座用测针		600341-8183-000	1	17.5			5	1	0.8		1
		600341-8185-000	2	28.5				1.5			1
圆盘测针		600341-8090-000	10	21.5	7					1.5	3
		600341-8095-000	15	21.5	10					1.5	6
		000000-1165-630	20	60	7					1	8
		000000-1165-629	15	40	7					1	5
测针加长杆 (铝)		600341-8420-000		200	20						85
		600341-8421-000		150	20						68
		600341-8422-000		100	20						50
		600341-8423-000		80	20						43
		600341-8424-000		60	20						37
		600341-8425-000		40	20						32
		600341-8265-000		120	11						30
		600341-8264-000		100	11						24
		600341-8263-000		80	11						19
		600341-8262-000		60	11						14
600341-8261-000		40	11						10		
测针加长杆 (不锈钢)		600341-0260-000		100	11						73
		600341-0258-000		80	11						58
		600341-0256-000		60	11						42
		600341-0254-000		40	11						28
		600341-0252-000		20	11						13
		600341-0251-000		15	11						9
600341-0250-000		10	11						6		

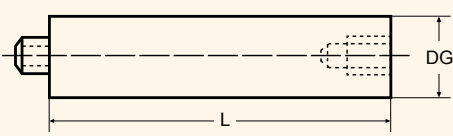
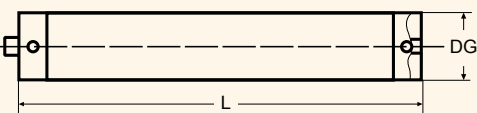
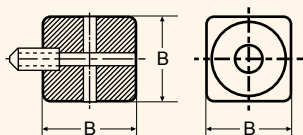
M5	概略形状	型号	各部尺寸 (mm)							重量 (g)		
			DK	L	DG	ML	MLE	DS	DSE		B	
测针加长杆 (钛) 		602030-9044-000		10	11						4	
		602030-9045-000		15	11						6	
		602030-9046-000		20	11						7	
		602030-9047-000		25	11						9	
		602030-9048-000		25	18						26	
		602030-9049-000		40	11						14	
		602030-9050-000		40	18						43	
		602030-9051-000		50	11						15	
		602030-9052-000		50	18						35	
		602030-9053-000		60	11						14	
		602030-9054-000		60	18						38	
		602030-9055-000		75	11						19	
		602030-9056-000		75	18						42	
		602030-9057-000		80	11						19	
		602030-9058-000		80	18						41	
		602030-9059-000		90	11						20	
		602030-9060-000		90	18						47	
		602030-9061-000		100	11						22	
		602030-9062-000		100	18						50	
		602030-9063-000		120	11						30	
602030-9064-000		120	18						56			
602030-9065-000		150	11						29			
602030-9066-000		150	18						68			
测针加长杆 (ThermoFit) 		626107-1040-100		40	11						9	
		626107-1050-100		50	11						10	
		626107-1060-100		60	11						11	
		626107-1070-100		70	11						11	
		626107-1075-100		75	11						12	
		626107-1080-100		80	11						12	
		626107-1090-100		90	11						13	
		626107-1100-100		100	11						14	
		626107-1120-100		120	11						15	
		626107-1150-100		150	11						17	
		626107-1180-100		180	11						19	
		626107-1200-100		200	11						21	
		626107-1220-100		220	11						22	
		626107-1250-100		250	11						24	
		626107-1300-100		300	11						27	
		626107-1400-100		400	11						34	
		626107-2040-100		40	20						26	
		626107-2050-100		50	20						28	
		626107-2060-100		60	20						29	
		626107-2080-100		80	20						32	
		626107-2100-100		100	20						34	
		626107-2120-100		120	20						37	
		626107-2150-100		150	20						41	
		626107-2180-100		180	20						45	
		626107-2200-100		200	20						48	
		626107-2250-100		250	20						55	
626107-2300-100		300	20						62			
626107-2400-100		400	20						75			
626107-2500-100		500	20						89			
626107-2600-100		600	20						103			
六面体适配器 		(钛)	600341-8361-000							15	13	
		(钛)	600341-8002-000								20	32
		(铝)	602030-8363-000								15	7.5
		(铝)	602030-8362-000								20	20

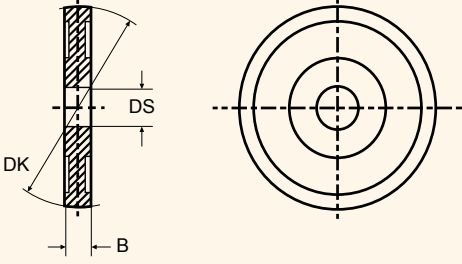
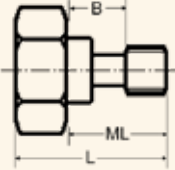
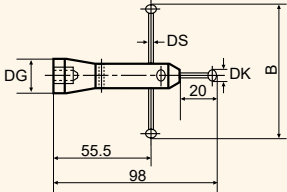
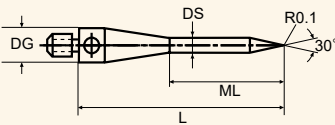
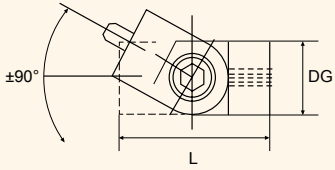
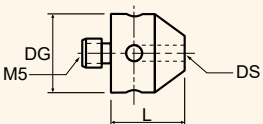
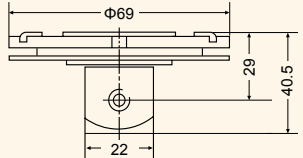
M5	概略形状	型号	各部尺寸 (mm)							重量 (g)	
			DK	L	DG	ML	MLE	DS	DSE		B
圆盘测针 (钢) 		602030-0003-000	10					M5		4	2
		602030-0004-000	15					M5		4	5
		602030-0005-000	20					M5		4	9
		602030-0006-000	30					M5		4	21
		602030-0007-000	40					M5		5	42
		602030-0008-000	50					M5		5	64
		602030-0009-000	60					M5		5	89
		602030-0010-000	15					8		4	4
		602030-0011-000	20					8		4	8
		600341-0200-000	20					8		2	4
		600341-0203-000	30					8		4	10
		600341-0204-000	40					8		4	21
		600341-0205-000	50					8		5	36
		600341-0206-000	60					8		6	59
圆盘测针用螺钉 		600341-0212-000		17.5		10				7	7
		600341-0210-000		35		26				24	9
星形测针 (红宝石球) 		600331-8093-000	5		19			3.5		80	70
针尖型测针 		600342-8051-000		61	11	39		3.5			12
接头 (钛) 		600342-9002-000		30	11						11
		626105-6280-070		36	20						
转接头 		602030-0315-000	M3	10	11						5
		602030-0215-000	M2	10	11						
HSS和VAST用吸盘*1 		600667-9611-000 (set of 2)									158

*1 最新的VAST测头 (VAST gold, VAST XT gold) 不能使老型号的吸盘 (型号: 000000-1054-593, 无ID贴纸).

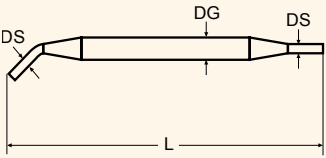
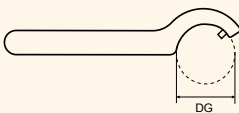
M5	概略形状	型号	各部尺寸 (mm)							重量 (g)	
			DK	L	DG	ML	MLE	DS	DSE		B
针形扳手		602030-0027-000		49	2.5			1.7			
		602030-0222-000		70	5			2.9			
勾形扳手		626109-0012-000			11						
		626109-0013-000			20						

M3 测针套件

测针组合

测针组合1 VAST XXT, 适用于小工件 型号: 626103-9021-000

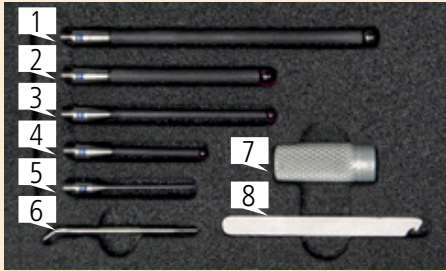

No	数	型号	详细	重量 (g)
1	1	626103-0500-075	测针, M3 XXT, ThermoFit, 氮化硅, DK5, L75	1.8
2	1	626103-0500-050	测针, M3 XXT, ThermoFit, 红宝石, DK5, L50	1.4
3	1	626103-0300-050	测针, M3 XXT, ThermoFit, 红宝石, DK3, L50	0.8
4	1	626103-0300-033	测针, M3 XXT, ThermoFit, 红宝石, DK3, L33	0.7
5	1	626113-0150-030	测针, M3 XXT, 超硬, 红宝石, DK1.5, L30	0.9
6	1	000000-0015-323	针形扳手 1.1, CZ-Norm 1170	0.6
7	1	626109-0026-000	测针安装用夹头XXT	1.5
8	2	626109-0018-000	勾形扳手 DG5	1.5

测针套件 2 VAST XXT, 适用于大工件 型号: 626103-9022-000

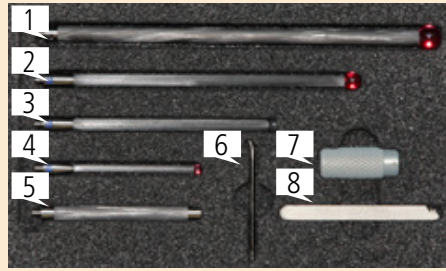

No	数	型号	详细	重量 (g)
1	1	626103-0800-125	测针, M3 XXT, ThermoFit, 红宝石, DK8, L125	2.9
2	1	626103-0600-100	测针, M3 XXT, ThermoFit, 红宝石, DK6, L100	2.4
3	1	626103-0500-075	测针, M3 XXT, ThermoFit, 氮化硅, DK5, L75	1.8
4	1	626103-0300-050	测针, M3 XXT, ThermoFit, 红宝石, DK3, L50	0.8
5	1	626103-5050-000	测针 加长杆, M3 XXT, ThermoFit, L50	1.5
6	1	000000-0015-323	针形扳手 1.1, CZ-Norm 1170	0.6
7	1	626109-0026-000	测针安装用夹头XXT	1.5
8	2	626109-0018-000	勾形扳手 DG5	1.5

测针组合4 VAST XXT, 小 型号: 626103-9024-000

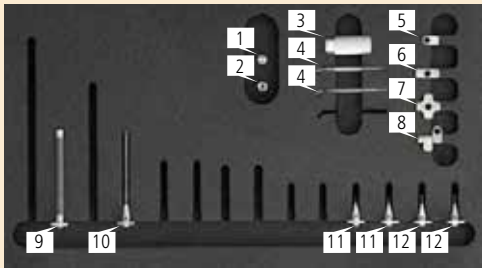

No	数	型号	详细	重量 (g)
1	1	626103-6110-004	固定螺钉, M3 XXT, DG3.5, L8	0.5
2	1	626103-6110-005	固定螺钉(附螺母), M3 XXT, 钛, DG3.5, L8	0.7
3	1	626109-0026-000	测针安装用夹头 XXT	1.9
4	2	000000-0015-323	针形扳手 1.1	0.6
5	1	626103-6110-001	六面体, M3 XXT, 90°, 单接口, B5, L6.5	0.6
6	1	626103-6110-002	六面体, M3 XXT, 180°, 双接口, B5, L13	1.1
7	1	626103-6110-003	六面体, M3 XXT, 星形, B5, L13	1.8
8	1	626103-6180-001	可变关节接头, M3 XXT, 钛, B5, L10	1.7
9	1	626103-5050-000	测针 加长杆, M3 XXT, ThermoFit, DGE5, LE50	1.5
10	1	626103-0300-050	测针, M3 XXT, 超硬, 红宝石, DK3, L50	0.8
11	2	626113-0050-013	测针, M3 XXT, 超硬, 红宝石, DK0.5, L13	0.6
12	2	626113-0080-014	测针, M3 XXT, 超硬, 红宝石, DK0.8, L14	0.6

测针组合5 VAST XXT, 大 型号: 626103-9025-000

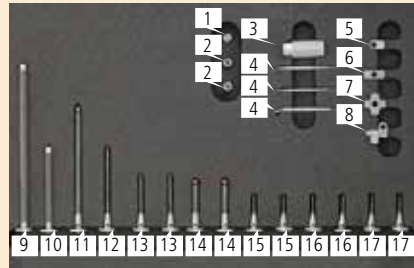

No	数	型号	详细	重量 (g)
1	1	626103-6110-004	固定螺钉	0.5
2	2	626103-6110-005	固定螺钉附螺母	0.7
3	1	626109-0026-000	测针安装用夹头XXT	1.9
4	3	000000-0015-323	针形扳手 1.1	0.6
5	1	626103-6110-001	六面体 90°, 单接口	0.6
6	1	626103-6110-002	六面体 180°, 双接口	1.1
7	1	626103-6110-003	六面体, 星形	1.8
8	1	626103-6180-001	可变关节接头 DG5	1.7
9	1	626103-5100-000	测针 加长杆 TF 5 x 100	2.1
10	1	626103-5050-000	测针 加长杆 TF 5 x 50	1.5
11	1	626103-0500-075	测针 TF, SiN 5 x 75	1.8
12	1	626103-0300-050	测针 TF, 红宝石 3 x 50	0.8
13	2	626103-0300-033	测针 TF, 红宝石 3 x 33	0.7
14	2	626103-0500-030	测针 TF, 红宝石 5 x 30	1.1
15	2	626113-0200-020	测针 HM, 红宝石 2 x 20	0.7
16	2	626113-0150-020	测针 HM, 红宝石 1.5 x 20	0.7
17	2	626113-0100-020	测针 HM, 红宝石 1 x 20	0.7

M3 测针套件

测针组合 VAST XXT (M3), 大 型号: 626103-9026-000

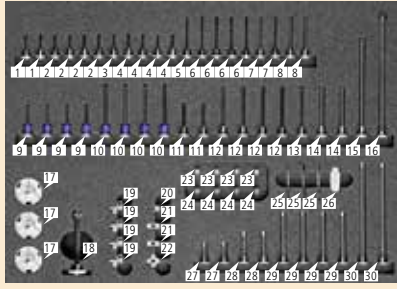

No	数	型号	详细	重量 (g)
12	4	626103-0300-050	测针, M3 XXT, ThermoFit, 红宝石, 3.0x50	0.8
13	1	626103-0401-050	测针, M3 XXT, ThermoFit, 红宝石, 4.0x50	1
14	2	626103-0500-050	测针, M3 XXT, ThermoFit, 红宝石, 5.0x50	1.4
15	1	626103-0600-100	测针, M3 XXT, ThermoFit, 红宝石, 6.0x100	2.4
16	1	626103-0800-125	测针, M3 XXT, ThermoFit, 红宝石, 8.0x125	2.9
17	3	620161-8075-000	交换架 ZSH-28-B-0-M3 for VAST XXT TL3	4.6
18	1	626103-8033-055	交换架 ZSH-28-B-55-X-TL3-M3 for VAST XXT TL3	6.3
19	4	626103-6180-001	铰链, M3 XXT, 钛, L10, B5	1.7
20	1	626103-6110-001	六面体 M3 XXT, 90°, 单接口 L6.5, B5	0.6
21	2	626103-6110-002	六面体 M3 XXT, 180°, 双接口 L13, B5	1.1
22	1	626103-6110-003	六面体 M3 XXT, 星形, L13, B5	1.8
23	4	626103-6110-004	固定螺钉, M3 XXT, 钛, DG3.5, L8	0.5
24	4	626103-6110-005	固定螺钉(附螺母), M3 XXT, 钛, DG3.5, L8	0.7
25	3	000000-0015-323	针形扳手 1.1	-
26	1	626109-0026-000	测针安装用夹头XXT	-
27	2	626103-5020-000	延长杆, M3 XXT, ThermoFit, 5x20	1.2
28	2	626103-5030-000	延长杆, M3 XXT, ThermoFit, 5x30	1.3
29	4	626103-5050-000	延长杆, M3 XXT, ThermoFit, 5x50	1.5
30	2	626103-5100-000	延长杆, M3 XXT, ThermoFit, 5x100	2
No	数	型号	详细	重量 (g)
1	2	626113-0030-020	测针, M3 XXT, 超硬, 红宝石, 0.3x20	0.7
2	4	626113-0050-020	测针, M3 XXT, 超硬, 红宝石, 0.5x20	0.7
3	1	626113-0080-020	测针, M3 XXT, 超硬, 红宝石, 0.8x20	0.7
4	4	626113-0103-020	测针, M3 XXT, 超硬, 红宝石, 1.0x20	0.7
5	1	626113-0100-040	测针, M3 XXT, 超硬, 红宝石, 1.0x40	1
6	4	626113-0150-030	测针, M3 XXT, 超硬, 红宝石, 1.5x30	0.9
7	2	626113-0151-040	测针, M3 XXT, 超硬, 红宝石, 1.5x40	1
8	2	626113-0201-040	测针, M3 XXT, 超硬, 红宝石, 2.0x40	1.5
9	4	626103-0207-030	滚花测针, M3 XXT, ThermoFit, 红宝石, 3.0x30	1
10	4	626103-0307-050	滚花测针, M3 XXT, ThermoFit, 红宝石, 3.0x50	1.2
11	2	626103-0300-033	测针, M3 XXT, ThermoFit, 红宝石, 3.0x33	0.7

星形测针套件 XXT TL3 gear measurement 型号: 626103-9034-000

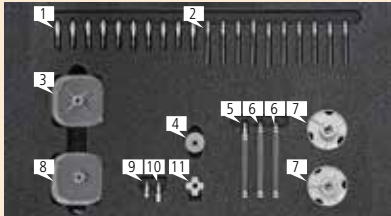

No	数	型号	详细	重量 (g)
4	1	626103-6110-007	六面体, M3 XXT, 钛, 8 x 45 Grad, DG14, B5	2.3
5	1	626103-5045-010	夹具用延长杆, M3 XXT, ThermoFit, DGE5, LE45	1.5
6	2	626103-5050-000	延长杆, M3 XXT, ThermoFit, DGE5, L50	1.5
7	2	620161-8075-000	交换架 ZSH-28-B-0-M3 for VAST XXT TL3	4.6
8	1	626103-0050-016	带六面体星形测针, M3 XXT, 超硬, 红宝石, DK0.5, L4, B16	0.9
9	1	626103-6110-004	固定螺钉, M3 XXT, L8, DG3.5	0.5
10	1	626103-6110-005	固定螺钉(附螺母), M3XXT, L8, DG3.5	0.7
11	1	626103-6110-003	六面体, M3XXT, 钛, L13, B5	1.8
No	数	型号	详细	重量 (g)
1	10	626113-0080-020	测针, M3 XXT, 超硬, 红宝石, DK0.8, L20	0.7
2	10	626113-0150-030	测针, M3 XXT, 超硬, 红宝石, DK1.5, L30	0.9
3	1	626103-0050-025	带六面体星形测针, M3 XXT, 超硬, 红宝石, DK0.5, L8.5, B25	1.2

星形测针套件 TL3 型号: 626103-9033-000

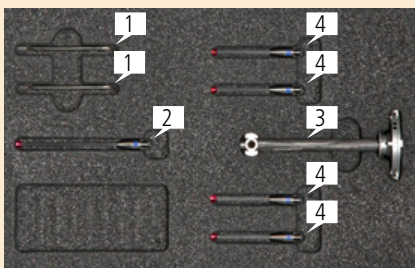

No	数	型号	详细	重量 (g)
1	2	000000-0015-323	针形扳手 1.1, ZEISS Norm 1170	0.6
2	1	626103-0300-050	测针, M3 XXT, ThermoFit, 红宝石, 3x50	0.8
3	1	626103-8033-055	交换架 ZSH-28-B-55-5X-TL3-M3, L55	6.3
4	4	626103-0300-033	测针, M3 XXT, ThermoFit, 红宝石, 3x33	0.7

星形测针套件 TL3 型号: 626103-9041-000

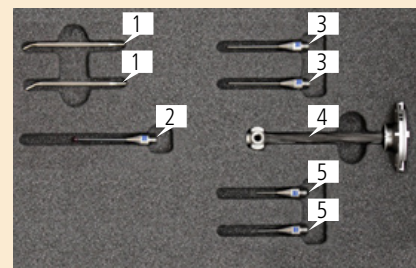

No	数	型号	详细	重量 (g)
1	2	000000-0015-323	针形扳手 1.1, ZEISS Norm 1170	0.6
2	1	626113-0200-030	测针, M3 XXT, 超硬, 红宝石 2x30	0.8
3	2	626113-0100-030	测针, M3 XXT, 超硬, 红宝石 1x30	0.8
4	1	626103-8033-055	星形测针用交换架 ZSH-28-B-55-5X-TL3-M3, L55	6.3
5	2	626113-0050-020	测针, M3 XXT, 超硬, 红宝石 0.5x33	0.7

M3 测针套件

带滚花测针的星形测针组合 TL3 型号: 626103-9043-000

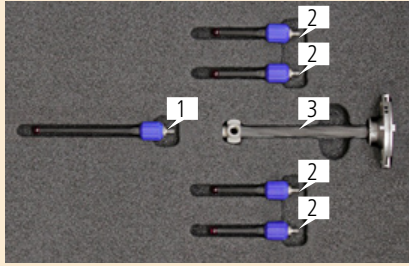

No	数	型号	详细	重量 (g)
1	1	626103-0307-050	滚花测针, M3 XXT, ThermoFit, 红宝石 3x50	1.2
2	4	626103-0307-030	滚花测针, M3 XXT, ThermoFit, 红宝石 3x30	1.1
3	1	626103-8033-055	星形测针用交换架 ZSH-28-B-55-5X-TL3-M3, L55	6.3

测针保持架组合 TL3, 长 型号: 626103-9058-000

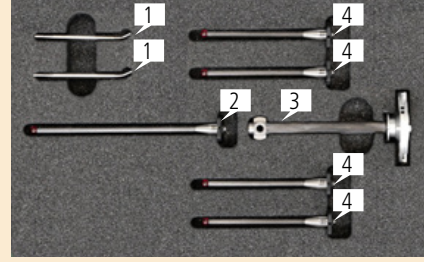

No	数	型号	详细	重量 (g)
1	2	000000-0015-323	针形扳手 1.1, CZ 1170	0.6
2	1	626103-0300-075	测针, M3 XXT, ThermoFit, 红宝石 3x75	1
3	1	626103-8033-055	交换架 ZSH-28-B-55-5X-TL3-M3	6.3
4	4	626103-0300-050	测针, M3 XXT, ThermoFit, 红宝石 3x50	0.8

M5 测针套件

测针套件/加长杆 kit

基本测针套件, M5 型号: 626115-9170-000

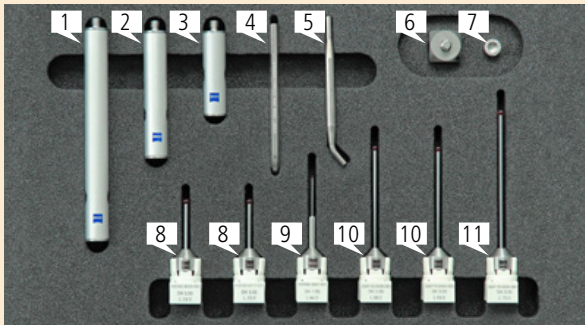

No	数	型号	详细	重量 (g)
1	1	600341-8264-000	加长杆, M5, 铝, DGE11, LE100	24
2	1	600341-8262-000	加长杆, M5, 铝, DGE11, LE60	15
3	1	600341-8261-000	加长杆, M5, 铝, DGE11, LE40	10
4	1	000000-0015-248	内六角扳手 DIN 911, SW4	9.8
5	1	000000-0015-328	针形扳手 2.9	6.7
6	1	600341-8361-000	六面体, M5, 钛, B15	13
7	1	626109-0015-000	六面体用螺钉, M5, V2A, L20, ML15	3
8	2	600342-8020-000	测针, M5, 超硬合金, 红宝石, DK3, DS2, L33.5, ML23.5	4.4
9	1	602030-8065-000	测针, M5, 超硬合金, 红宝石, DK1.5, DS4, DSE1, L44, ML19	7.2
10	2	600342-8021-000	测针, M5, 超硬合金, 红宝石, DK3, DS2, L58, ML48	5.5
11	1	626115-0301-075	测针, M5, 超硬合金, 红宝石, DG11, DK3, DS2, L75, ML65	8.7

标准测针套件, M5 型号: 626115-9100-000¹

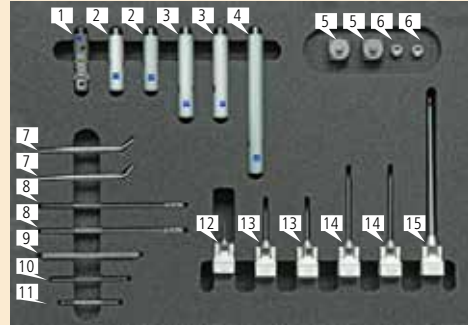

No	数	型号	详细	重量 (g)
1	1	626105-6280-040	旋转关节 M5, 钛, DG11, L40	16
2	2	600341-8261-000	加长杆, M5, 铝, DGE11, LE40	10
3	2	600341-8262-000	加长杆, M5, 铝, DGE11, LE60	15
4	1	600341-8264-000	加长杆, M5, 铝, DGE11, LE100	24
5	2	600341-8361-000	六面体, M5, 钛, B15	13
6	2	626109-0015-000	六面体用螺钉, M5, Inox, L20, ML15	3
7	2	602030-0222-000	针形扳手, 2.9, DG5, DS2.9, L70	8
8	2	626109-0012-000	钩形扳手 DG11	19
9	1	000000-0015-248	内六角扳手 (DIN 911) SW 4mm	10
10	1	602030-0021-000	内六角扳手 DIN 911, SW 2.5 mm	3
11	1	626109-0035-000	梅花扳手 T6	2
12	1	626115-0050-022	测针, M5, 超硬合金, 红宝石, 0.5x22	6
13	2	600342-8020-000	测针, M5, 超硬合金, 红宝石, DK3, L33.5	4.4
14	2	600342-8021-000	测针, M5, 超硬合金, 红宝石, DK3, L58	5.5
15	1	600342-8024-000	测针, M5, 超硬合金, 红宝石, DK8, L114.5	49

*1 作为 Fusion NEX VAST XT gold标准配件提供

M5 测针套件

高级测针套件, M5 型号: 626115-91110-000

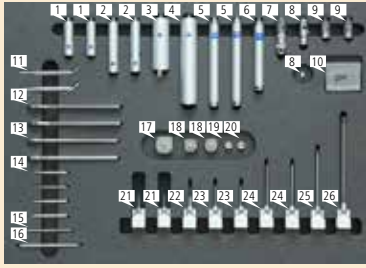

No	数	型号	详细	重量 (g)
10	1	626119-0001-019	锥形槽用螺钉, M3 (10 pcs.)	1
11	2	602030-0222-000	针形扳手, DG5, DS2.9, L70	8
12	2	626109-0013-000	勾形扳手, DG20	23
13	2	626109-0012-000	勾形扳手, DG11	19
14	4	626109-0035-000	梅花扳手T6	2
15	1	602030-0021-000	内六角扳手 DIN 911, BSW 2.5	3
16	1	000000-0015-248	内六角扳手 DIN 911, BSW 4	10
17	1	600341-8002-000	六面体, M5, 钛, B20	32
18	2	600341-8361-000	六面体, M5, 钛, B20	13
19	1	626109-0016-000	六面体用螺钉, M5, Inox, L20, ML20	3
20	1	626109-0015-000	六面体用螺钉, M5, Inox, L20, ML15	3
21	2	626115-0050-022	测针, M5, 超硬合金, 红宝石, DK0.5, L22	6
22	1	602030-8061-000	测针, M5, 超硬合金, 红宝石, DK1, L32	7
23	2	600342-8020-000	测针, M5, 超硬合金, 红宝石, DK3, L33.5	4
24	2	600342-8021-000	测针, M5, 超硬合金, 红宝石, DK3, L58	6
25	1	602030-9015-000	测针, M5, 超硬合金, 红宝石, DK5, L75	13
26	1	626105-0820-114	测针, M5, ThermoFit, 红宝石, DK8, L114	10
1	2	600341-8261-000	加长杆, M5, 铝, DGE11, LE40	10
2	2	600341-8262-000	加长杆, M5, 铝, DGE11, LE60	15
3	1	600341-8424-000	加长杆, M5, 铝, DGE20, LE60	37
4	1	600341-8422-000	加长杆, M5, 铝, DGE20, LE100	50
5	2	626107-1100-100	加长杆, M5, ThermoFit silver, DGE11, LE100	14
6	1	626107-1080-100	加长杆, M5, ThermoFit silver, DGE11, LE80	12
7	1	626105-6280-040	旋转关节, M5, 钛, DG11, L40	16
8	1	600342-9002-000	关节接头, M5, 钛, DG11, L30 with screw	11
9	2	626105-6280-020	旋转接头, M5, 钛, DG11, L20	7

专业测针套件, M5 型号: 626115-9120-000

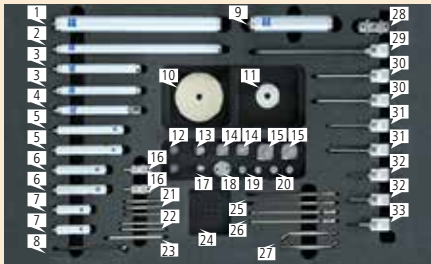

No	数	型号	详细	重量 (g)
14	2	600341-8361-000	六面体, M5, 钛, B15	15
15	2	600341-8002-000	六面体, M5, 钛, B20	32
16	2	626107-6280-040	带锥形适配器的六面体, 钛, DG11, L19	11
17	1	626107-6280-010	90° 末端件, 钛, DG11, L15.5, ML10, B5.5	5
18	1	626105-6271-001	陶瓷球盘适配器(DS8), M5	8
19	2	626109-0015-000	六面体用螺钉, M5, V2A, L20, ML15	3
20	2	626109-0016-000	六面体用螺钉, M5, V2A, L25, ML20	3
21	3	626109-0035-000	梅花扳手 T6	2
22	2	602030-0021-000	内六角扳手 DIN 911, BSW2.5	3
23	1	000000-0015-248	内六角扳手 DIN911, SW4	10
24	2	626119-0001-019	锥形槽用螺丝, M3 (10 pcs.)	5
25	2	626109-0012-000	勾形扳手, Dmr. 11 x 2.8 mm	19
26	2	626109-0013-000	勾形扳手, Dmr. 20 x 2.8 mm	23
27	2	602030-0222-000	针形扳手, 2.9, DG5, DS2.9, L70	8
28	1	626105-6280-070	关节接头, M5, DG20, 钛, L36	43
29	1	626105-0820-150	测针, M5, ThermoFit, 红宝石, DG11, DK8, DS6, L150, ML137	12
30	2	602030-9015-000	测针, M5, 超硬合金, 红宝石, DG11, DK5, DS3, L75, ML65	13
31	2	600342-8021-000	测针, M5, 超硬合金, 红宝石, DGE11, DK3, DS2, L58, ML48	6
32	1	600342-8020-000	测针, M5, 超硬合金, 红宝石, DG11, DK3, DS2, L33.5, ML23.5	5
33	2	602030-8061-000	测针, M5, 超硬合金, 红宝石, DG11, DK1, DS1, DSE0.8, L32, ML12, MLE5	7
1	1	626107-2200-100	加长杆, M5, ThermoFit silver, DGE20, LE200	48
2	1	626107-1200-100	加长杆, M5, ThermoFit silver, DGE11, LE200	21
3	2	626107-1100-100	加长杆, M5, ThermoFit silver, DGE11, LE100	14
4	1	626107-1100-105	带锥形槽的加长杆, ThermoFit silver, DGE11, LE100	17
5	2	600341-8263-000	加长杆, M5, 铝, DGE11, LE80	19
6	2	600341-8262-000	加长杆, M5, 铝, DGE11, LE60	15
7	2	600341-8261-000	加长杆, M5, 铝, DGE11, LE40	10
8	1	626109-0041-000	双销扳手 (DIN 3116A, 销径 $\Phi 2.5 \times 3$ mm, 销距 13mm)	20
9	1	626107-2100-100	加长杆, M5, ThermoFit silver, DGE20, LE10	34
10	1	626101-6000-004	球盘陶瓷, 陶瓷, DK60, B2, 适配器 DS8	43
11	1	626101-3000-002	球盘陶瓷, 陶瓷, DK30, B2, 适配器 DS8	5
12	2	626107-1015-105	带锥形槽的加长杆, 钛, DGE11, LE15	5
13	1	626107-6280-070	带锥形适配器的六面体, M5, 钛, L17.5, ML10, B15, DG11	13

M5 测针套件

专家级测针套件, M5 型号: 626115-9130-000

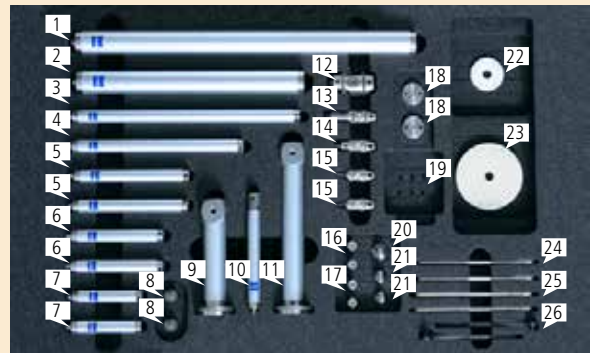
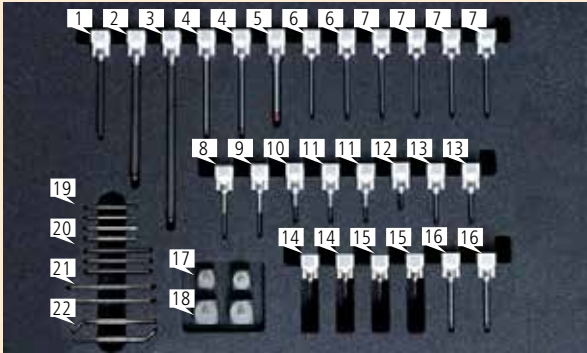

下层					上层				
No	数	型号	详细	重量 (g)	No	数	型号	详细	重量 (g)
1	1	626105-0510-075	测针, M5, ThermoFit, 红宝石, DG11, DK5, DS3.5, L75, ML65	5	1	1	626107-2300-100	加长杆, M5, ThermoFit silver, DGE20, LE300	62
2	1	626105-0820-114	测针, M5, ThermoFit, 红宝石, DG11, DK8, DS6, L114, ML101	10	2	1	626107-2200-100	加长杆, M5, ThermoFit silver, DGE20, LE200	48
3	1	626105-0820-150	测针, M5, ThermoFit, 红宝石, DG11, DK8, DS6, L150, ML137	12	3	1	626107-1200-100	加长杆, M5, ThermoFit silver, DGE11, LE200	21
4	2	602030-9015-000	测针, M5, 超硬合金, 红宝石, DG11, DK5, DS3, L75, ML65	13	4	1	626107-1150-100	加长杆, M5, ThermoFit silver, DGE11, LE150	17
5	1	600342-8023-000	测针, M5, 超硬合金, 红宝石, DG11, DK8, DS6, L63.5, ML50.5	25	5	2	626107-1100-100	加长杆, M5, ThermoFit silver, DGE11, LE100	14
6	2	626115-0300-058	测针, M5, 超硬合金, 氮化硅, DG11, DK3, DS2, L58, ML48	8	6	2	626107-1080-100	加长杆, M5, ThermoFit silver, DGE11, LE80	12
7	4	600342-8021-000	测针, M5, 超硬合金, 红宝石, DGE11, DK3, DS2, L58, ML48	6	7	2	626107-1060-100	加长杆, M5, ThermoFit silver, DGE11, LE60	11
8	1	602030-8067-000	测针, M5, 超硬合金, 红宝石, DG11, DK2, DS1.5, L44, ML19	5	8	2	626107-1015-105	带锥形槽的测针加长杆, 钛, DGE11, LE15	5
9	1	602030-8065-000	测针, M5, 超硬合金, 红宝石, DG11, DK1.5, DS4, DSE1, L44, ML19	7	9	1	626107-2050-110	杆块一体加长杆, M5, ThermoFit silver, 六面体接头 20, DGE20, LE50, ML96.5, B20	78
10	1	602030-8061-000	测针, M5, 超硬合金, 红宝石, DG11, DK1, DS1, DSE0.8, L32, ML12, MLE5	7	10	1	626107-1100-105	带锥形槽的加长杆, ThermoFit silver, DGE11, LE100	17
11	2	602030-8060-000	测针, M5, 超硬合金, 红宝石, DG11, DK0.8, DS1, DSE0.6, L32, ML12, LE4.8	7	11	1	626107-2100-110	杆块一体加长杆, M5, ThermoFit silver, 六面体接头 20, DGE20, LE100, ML146.5, B20	84
12	1	626115-0100-022	测针, M5, 超硬合金, 红宝石, DG11, DK1, DS1, DSE0.8, L22.5, ML12.5, MLE5	6	12	1	626105-6280-070	指节接头, M5, DG20, 钛, L36	43
13	2	600342-8020-000	测针, M5, 超硬合金, 红宝石, DG11, DK3, DS2, L33.5, ML23.5	5	13	1	626105-6280-040	旋转关节, M5, 钛, DG11, L40, 旋转角度360°, 关节可变角度 +/- 90°	16
14	2	626115-0030-022	测针, M5, 超硬合金, 红宝石, DG11, DK0.3, DS1, DSE0.2, L21.8, ML12.8, LE2.3	6	14	1	600342-9002-000	关节接头, M5, 钛, DG11, L30	11
15	2	626115-0050-022	测针, M5, 超硬合金, 红宝石, DG11, DK0.5, DS1, DSE0.3, L22, ML13, MLE2.5	6	15	2	626107-6280-040	带锥形适配器的指节接头, 适配器, 钛	11
16	2	602030-9013-000	测针, M5, 超硬合金, 红宝石, DGE11, DK5, DS3.5, L50, ML40	9	16	2	626109-0015-000	六面体用螺丝, M5, Inox, L20, ML15	3
17	2	600341-8361-000	六面体, M5, 钛, B15	15	17	2	626109-0016-000	六面体用螺丝, M5, Inox, L25, ML20	3
18	2	600341-8002-000	六面体, M5, 钛, B20	32	18	2	626105-6271-001	陶瓷球盘适配器(DS8), M5	8
19	4	626109-0035-000	梅花扳手T6	2	19	2	626119-0001-019	锥形槽用螺丝, M3 (10 pcs.)	5
20	3	602030-0021-000	内六角扳手 DIN 911, BSW2,5	3	20	1	626107-6280-070	带锥形适配器的六面体 15, M5, 钛, L17.5, ML10, B15, DG11	13
21	2	000000-0015-248	内六角扳手 DIN911, SW4	10	21	2	626107-6280-010	90° 末端件, 钛, DG11, L15.5, ML10, B5.5	5
22	2	602030-0222-000	针形扳手, 2.9, DG5, DS2.9, L70	8	22	1	626101-3000-002	球盘陶瓷, 陶瓷, DK30, B2, 适配器 DS8	5
					23	1	626101-6000-004	球盘陶瓷, 陶瓷, DK60, B2, 适配器 DS8	43
					24	2	626109-0012-000	勾形扳手, Dmr. 11 x 2.8 mm	19
					25	2	626109-0013-000	勾形扳手, Dmr. 20 x 2.8 mm	23
					26	2	626109-0041-000	双销扳手 (DIN 3116A, 销径 Φ2.5 x 3 mm, 销距 13 mm)	20

M5 测针套件

星形测针套件, M5 型号: 626115-9140-000

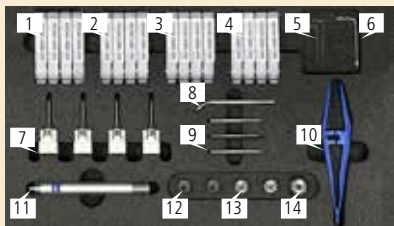

No	数	型号	详细	重量 (g)
1	4	600341-8450-000	测针, 超硬合金, 红宝石, DK0.3, DS1, DSE0.2, L15.3, MLE2.3	0.1
2	4	600341-8451-000	测针, 超硬合金, 红宝石, DK0.5, DS1, DSE0.3, L15.5, MLE2.5	0.1
3	4	600341-8454-000	测针, 超硬合金, 红宝石, DK1, DS1, DSE0.8, L16, MLE5	0.2
4	4	600341-8501-000	测针, 超硬合金, 红宝石, DK1.5, DS1, L26.5	1
5	2	602030-0042-000	内六角扳手 DIN 911, BSW0.9 DIN 911, SW0.9	0.2
6	1	626119-0001-019	锥形槽用螺丝, M3 (10 pcs.), with 梅花扳手T6	1.1
7	4	600342-8020-000	测针, M5, 超硬合金, 红宝石, DG11, DK3, DS2, L33.5, ML23.5	4.4
8	1	602030-0222-000	针形扳手 2.9, DG5, DS2.9, L70	7.5
9	3	626109-0035-000	梅花扳手T6	2
10	1	626109-0022-000	镊子, 蓝色	5.8
11	1	626107-1100-105	带锥形槽的测针加长杆, ThermoFit silver, DGE11, LE100	17
12	2	626107-1015-105	带锥形槽的测针加长杆, 钛, DGE11, LE15	5
13	2	626107-6280-050	带锥形适配器的1mm星形测针, 钛, DG11, L10, DS1	4.1
14	1	626107-6280-070	带锥形适配器的六面体 15, M5, 钛, L17.5, ML10, B15, DG11	13

小型星形测针套件, M5 型号: 626115-9150-000

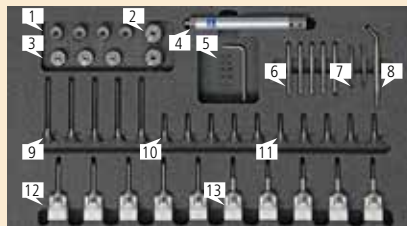

No	数	型号	详细	重量 (g)
1	1	626107-1015-105	带锥形槽的测针加长杆, 钛, DGE11, LE100	5
2	2	626107-6280-070	带锥形适配器的六面体 15, M5, 钛, L17.5, ML10, B15, DG11	13
3	3	626107-6280-060	带锥形适配器的5方向星形测针, M3 XXT, 钛, DG11, L10, ML5	5
4	1	626107-1100-105	带锥形槽的测针加长杆, ThermoFit silver, DGE11, LE100	17
5	1	626119-0001-019	锥形槽用螺钉, M3 (10 pcs.), 配合 梅花扳手T6 使用	1
6	5	626109-0035-000	梅花扳手T6	2
7	2	000000-0015-323	针形扳手, 1.1	1
8	1	602030-0222-000	针形扳手, 2.9	8
9	5	626103-0300-050	测针, M3 XXT, ThermoFit, 红宝石, DG5, DK3, DS2, L50, ML41	1
10	5	626113-0050-020	测针, M3 XXT, 红宝石, DG5, DK0.5, L20, ML11, MLE2.3, DS1, DSE0.3	1
11	5	626113-0030-020	测针, M3 XXT, 红宝石, DG5, DK0.3, L20, ML11, MLE2.3, DS1, DSE0.2	1
12	5	600342-8020-000	测针, M3 XXT, 超硬合金, 红宝石, DG11, DK3, DS2, L33.5, ML23.5	4
13	1	602030-8061-000	测针, M3 XXT, 超硬合金, 红宝石, DG11, DK1, L32, ML12, MLE5, DS1, DSE0.8	8

盘形测针套件 型号: 626115-9160-000

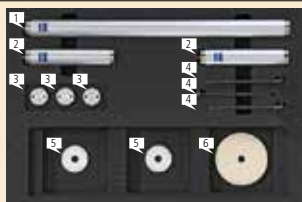

No	数	型号	详细	重量 (g)
1	1	626107-2300-100	加长杆, ThermoFit silver, DGE20, LE300	62
2	2	626107-2100-100	加长杆, ThermoFit silver, DGE20, LE100	34
3	3	626105-6271-001	陶瓷球盘适配器 DS8	6
4	3	626109-0041-000	双销扳手 13 x 2.5	35
5	2	626101-3000-002	球盘陶瓷, 陶瓷, DK30, B2, 适配器 DS8	5
6	1	626101-6000-004	球盘陶瓷, 陶瓷, DK60, B2, 适配器 DS8	43

M5 测针/加长杆 套件

ThermoFit 加长杆套件 $\phi 11$ 用 型号: 626107-9013-100

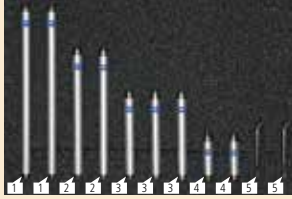

No	数	型号	详细	重量 (g)
1	2	626107-1200-100	加长杆, M5, ThermoFit Silver, DGE11, LE200	21
2	2	626107-1150-100	加长杆, M5, ThermoFit Silver, DGE11, LE150	17
3	3	626107-1100-100	加长杆, M5, ThermoFit Silver, DGE11, LE100	14
4	2	626107-1050-100	加长杆, M5, ThermoFit Silver, DGE11, LE50	10
5	2	000000-0015-328	针形扳手 2.9	6.7

ThermoFit 加长杆套件 $\phi 20$ 用 型号: 626107-9014-100

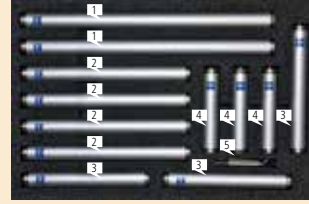

No	数	型号	详细	重量 (g)
1	2	626107-2300-100	加长杆, ThermoFit silver, DGE20, LE300	62
2	4	626107-2200-100	加长杆, ThermoFit silver, DGE20, LE200	48
3	3	626107-2150-100	加长杆, ThermoFit silver, DGE20, LE150	41
4	3	626107-2100-100	加长杆, ThermoFit silver, DGE20, LE100	34
5	2	000000-0015-328	针形扳手 2.9	6.7

ThermoFit 测针和加长杆套件 型号: 626107-9010-000

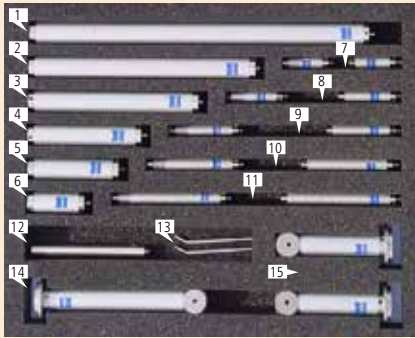

No	数	型号	详细	重量 (g)	No	数	型号	详细	重量 (g)
1	1	626107-2300-100	加长杆, M5, ThermoFit silver, DGE20, LE300	62	19	3	626105-0511-075	测针, M5, ThermoFit, 氮化硅, DG11, DK5, DS3.5, L75, ML65	5
2	1	626107-2200-100	加长杆, M5, ThermoFit silver, DGE20, LE200	48	20	3	626105-0511-050	测针, M5, ThermoFit, 氮化硅, DG11, DK5, DS3.5, L50, ML40	4
3	1	626107-2150-100	加长杆, M5, ThermoFit silver, DGE20, LE150	41	21	3	626105-0301-058	测针, M5, ThermoFit, 氮化硅, DG11, DK3, DS2, L58, ML48	4
4	1	626107-2100-100	加长杆, M5, ThermoFit silver, DGE20, LE100	34	22	1	000000-0015-248	内六角扳手 (DIN 911) SW 4 mm	10
5	1	626107-2080-100	加长杆, M5, ThermoFit silver, DGE20, LE80	32	23	1	000000-0015-247	内六角扳手 (DIN 911) SW 3 mm	5
6	1	626107-2050-100	加长杆, M5, ThermoFit silver, DGE20, LE50	28	24	1	602030-0021-000	内六角扳手 DIN 911, SW 2.5 mm	3
7	2	626107-1040-100	加长杆, M5, ThermoFit silver, DGE11, LE40	9	25	1	000000-0015-245	内六角扳手 (DIN 911) SW 2 mm	2
8	2	626107-1050-100	加长杆, M5, ThermoFit silver, DGE11, LE50	10	26	1	602030-0002-000	内六角扳手 DIN 911, SW 1.5 mm	1
9	2	626107-1060-100	加长杆, M5, ThermoFit silver, DGE11, LE60	11	27	2	600342-9002-000	关节接头, M5, 钛, DG11, L30	11
10	2	626107-1080-100	加长杆, M5, ThermoFit silver, DGE11, LE80	12	28	4	600341-8361-000	六面体, M5, 钛, B15	13
11	2	626107-1100-100	加长杆, M5, ThermoFit silver, DGE11, LE100	14	29	2	600341-8002-000	六面体, M5, 钛, B20	32
12	1	600341-0260-000	加长杆, M5, V2A, DGE11, LE100	73	30	1	626109-0017-000	六面体用螺钉, M5, V2A, L27, ML22	4
13	2	602030-0222-000	针形扳手, DG5, DS2.9, L70	7.5	31	1	626109-0016-000	六面体用螺钉, M5, V2A, L25, ML20	3
14	1	626107-2100-110	杆块一体加长杆, M5, ThermoFit silver, 六面体 20, DGE20, LE100, ML146.5, B20	84	32	1	626109-0015-000	六面体用螺钉, M5, V2A, L20, ML15	3
15	2	626107-2050-110	杆块一体加长杆, M5, ThermoFit silver, 六面体 20, DGE20, LE50, ML96.5, B20	78	33	1	626109-0010-000	梅花扳手 2 Nm 2.5 mm	145
16	1	626105-1021-200	测针, M5, ThermoFit, 氮化硅, DG11, DK10, DS6, L200, ML187	15	34	2	626105-6280-020	旋转接头, M5, 钛, DG11, L20	7
17	2	626105-0821-150	测针, M5, ThermoFit, 氮化硅, DG11, DK8, DS6, L150, ML137	12	35	2	626109-0012-000	勾形扳手 DIN 1810B, Dmr. 11 x 2.8 mm	19
18	2	626105-0821-114	测针, M5, ThermoFit, 氮化硅, DG11, DK8, DS6, L114, ML101	10	36	2	626109-0013-000	勾形扳手 DIN 1810B, Dmr. 20 x 2.8 mm	23

M5 测针/加长杆 套件

ThermoFit 测针与延长杆小套件 型号: 626107-9011-000

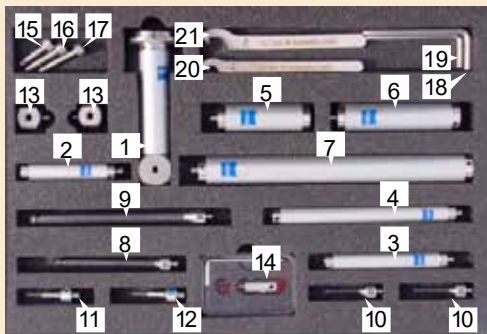

No	数	型号	详细	重量 (g)
6	1	626107-2080-100	加长杆, ThermoFit silver, 20 x 80	32
7	1	626107-2180-100	加长杆, ThermoFit silver, 20 x 180	45
8	1	626105-0511-075	测针, ThermoFit, 氮化硅 5 x 75	5
9	1	626105-0821-114	测针, ThermoFit, 氮化硅 8 x 114	10
10	2	626105-0301-033	测针, ThermoFit, 氮化硅 3 x 33	4
11	1	602030-8066-000	测针, 超硬合金, 红宝石 2 x 32	7.2
12	1	602030-8064-000	测针, 超硬合金, 红宝石 1.5 x 32	6.7
13	2	600341-8361-000	六面体 B15	13
14	1	626105-6280-020	旋转接头 DG11, L20	7.2
15	1	626109-0015-000	六面体用螺钉 M5, L20, ML15	3
16	1	626109-0016-000	六面体用螺钉 M5, L25, ML20	3
17	1	626109-0017-000	六面体用螺钉 M5, L27, ML22	4
18	1	000000-0015-247	内六角扳手, 3	4.8
19	1	000000-0015-248	内六角扳手, 4	9.8
20	2	626109-0012-000	勾形扳手 DG11	19
21	2	626109-0013-000	勾形扳手 DG20	23
1	1	626107-2050-110	杆块一体加长杆, ThermoFit silver, L50, 六面体 20	78
2	1	626107-1060-100	加长杆, ThermoFit silver, 11 x 60	11
3	1	626107-1080-100	加长杆, ThermoFit silver, 11 x 80	12
4	1	626107-1120-100	加长杆, ThermoFit silver, 11 x 120	15
5	1	626107-2060-100	加长杆, ThermoFit silver, 20 x 60	29

多库位支架(MSR)

部件名称	型号	各部尺寸 (mm)		概略形状	Machine
		W	H		
MSR B800/H450	626100-9302-010	800	450	A	FUSION NEX X = 650/850, AXCEL RDS X \geq 850
MSR B1000/H550	626100-9312-000	1000	550	A	FUSION NEX X = 1000, AXCEL RDS X \geq 1000 and Z \geq 800
MSR B1250/H800	626100-9332-000	1250	800	A	FUSION NEX X = 1200
MSR MINI 720/450	626100-9392-000	720	450	B	AXCEL RDS

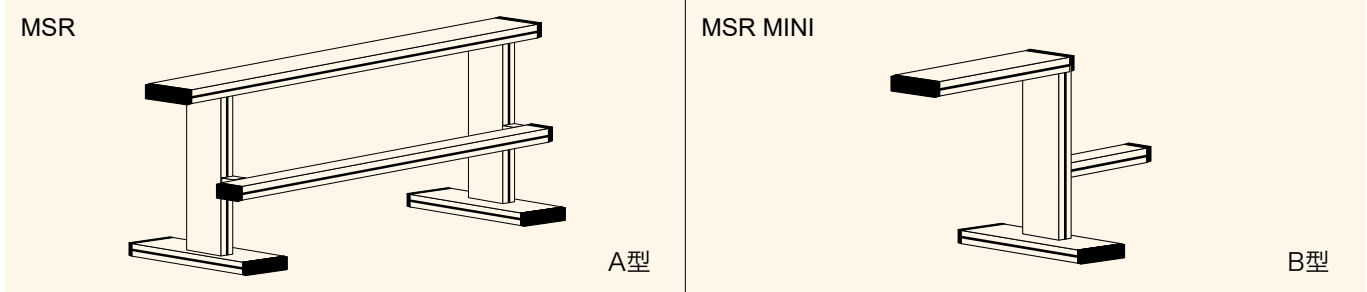

测针交换架用 AXCEL 专用基座

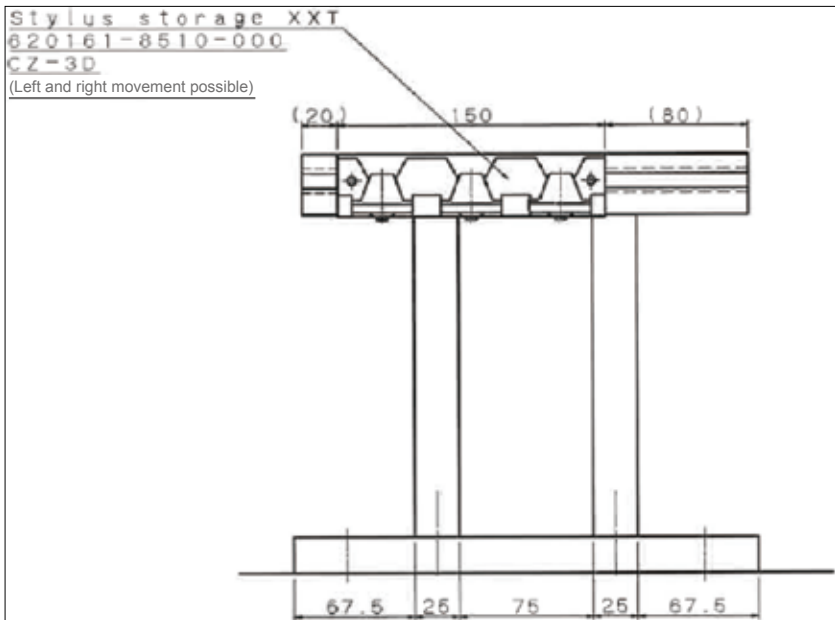

型号	各部尺寸 (mm)	
	W	H
CM99901-D150-00	250	235

* 测针库位 1 个可收纳最多3 个测针。

库位/交换架

概略形状	型号
吸盘库位 VAST 	600660-8365-000
测头库位 RDS 	621770-8040-000
吸盘库位 VAST XXT 	620161-8510-000